

1. storeWALL Basics
2. Installation Types
 - 2.1 InstallStrips
 - 2.2 Screws
3. Trim Options
4. Fabrication
5. Maintain & Repair
6. Concrete & Block Installation
7. Screws
8. Box Extenders
9. Baseboard
10. Shelf Options
 - 10.1 5" Shelf
 - 10.2 10" Shelf & Bracket



1. storeWALL BASICS



Heavy Duty Strength Wall Panels

Heavy Duty Thermoplastic
For durability, strength and consistency

InstallStrip Installation
Patented backside profile for an easy 3 step installation.

Modular
15 inch & 12 inch high panel sizes allow ease of design and installation

Solid Core
100% waterproof, mold, mildew, stain resistant, and easy to clean. For indoor or outside applications

Industrial Strength
For maximum load holding and rugged performance

Installs on Any Surface
Installs on wood or metal studs and on concrete

Seamless - Fastener Free Installation
The cleanest wall system in the market

Accessories
Compatible with conventional slatwall accessories

100% Recyclable
Class 3 recyclable

Exclusive CamLok™
Keeps accessories locked in place

Heavy Duty Backplate
Engineered tough for the most demanding applications

STW 10 Powder Coat Finish
Extra heavy coating to resist dings and protect against rust

Industrial Grade Steel
Engineered strong to hold your most valuable equipment

Rubberized Grip
For extra grip and prevents damage to your items

storeWALL's 10 year Warranty
Performance guaranteed to last 10 years..No questions asked

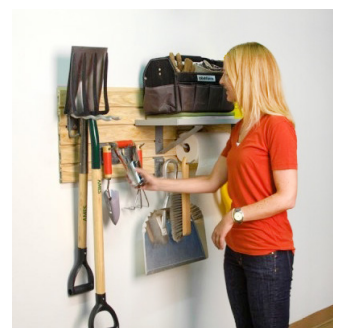
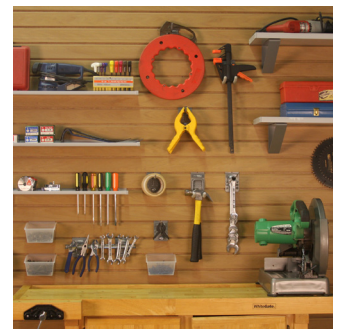

2. INSTALLATION TYPES

2.1 InstallStrips

With storeWALL's patented InstallStrip, one person can easily install the wall system on virtually any surface. Installations have superior strength from added contact points and are cost effective. You can add or change panels at any time. InstallStrip installations have no visible screws or fasteners; resulting in a handsome, versatile storage system.



Step 1: Make a level line at the top of desired location

(Use a laser, level or string for accuracy)



Step 2: Screw InstallStrips on each wall stud



Step 3: Place storeWALL panels on the InstallStrips

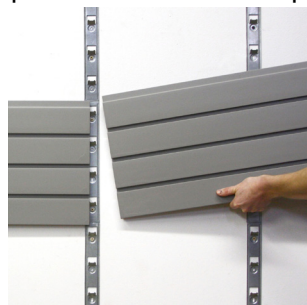

INSTALLSTRIP ATTRIBUTES

Break Points

The InstallStrip comes in three sections that can be separated by snapping at the desired break point.

Versatile Installation

Can be mounted to any wall surface: Drywall, wood, metal studs & concrete.

Slotted Panel Grips

Behind each panel slat is a slotted grip to provide maximum strength for storeWALL's panels

Gripper Teeth

The teeth on each InstallStrip grab the panel to prevent wall movement.

Increased Load Capacity

The Gripper Teeth add contact points to the wall system to increase the wall load capacity compared to screw installation and help redistribute the weight evenly.

2.2 Screws

storeWALL panels can also be screwed directly into the studs of the wall. This option is not as strong as our installstrips installation but is best if the wall or studs are uneven.

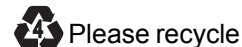
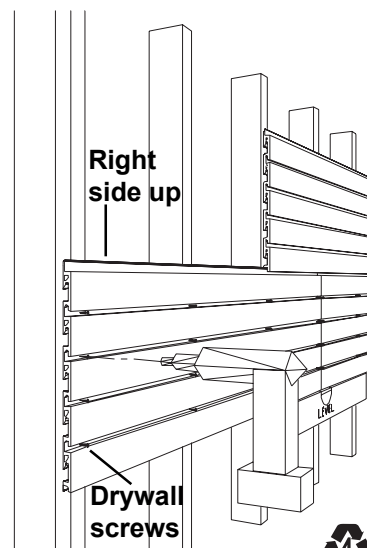

Secure the first panel by driving screws, through the slots of the panel front face, directly into the wall studs or blocking.

No pre-drilling or countersinking is necessary. The screw head will flush up with the slot surface.

Use storeWALL's color matching screws for best match to our wall panels.

Watch our simple InstallStrip installation:



For more information please contact us:

(866) 889-2502 (toll free, continental US)
(414) 434-1620 (direct, Hawaii and Alaska)
(414) 434-1621 (fax)

Outside the US: +1 414-434-1620

By Email: Sales@storeWALL.com

Web: www.storeWALL.com

3. TRIM OPTIONS

storeWALL's trim is perfect for hiding any seam, corner or edge. For the sleekest look we recommend using our color matching trim. We offer multiple trim options to match all your seam needs.

Procedure to install trim:

Step 1: Measure the desired length of trim to cover the panel location for which you intend to use it.

Step 2: Cut the trim using a standard circle or table saw.

Step 3: Use an adhesive to secure the trim in its location. We recommend super glue or double sided sticky tape.

Trim Styles:



Flat trim
96" L x 1-1/8" W x 1/8" thick
Use for butt joints and inside corners.



Small L trim
96" L x 5/8" W x 3/4" D x 1/8" thick
Use as wall end caps.



Wide L trim
96" L x 1-1/8" W x 3/4" D x 1/8" thick
Use as wall end caps.

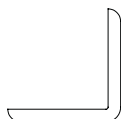

Large L trim
96" L x 1-1/8" W x 1-1/8" D x 1/8" thick
Use for outside wall corners.

Panel Edge



Panel Seam

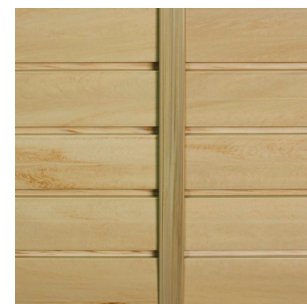

Panel Corner



Panel Top

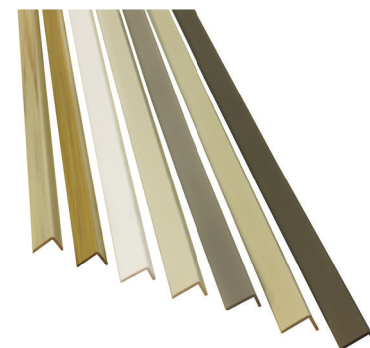

Available Finishes



Brite White Weathered Grey Rustic Cedar Global Pine Graphite Steel

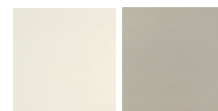

Dover White Khaki

4. FABRICATION

4.1 CUTTING

StoreWALL cuts easily using any traditional wood working tool. You will get good results using conventional saw blades, drills, routers, etc. The cleanest cuts are achieved with a 32 tooth, or larger, carbide blade (triple chip). Blades normally used for cutting MDF (Medium Density Fiber board) and laminates work well. Treat storeWALL like any prefinished material:

- cut "good side up" on a table saw
- cut "good side down" with a Skilsaw / radial arm saw / sabre saw.



Skil Flooring Saw Model #3600



Saw cuts are quick and clean. This cut is with storeWALL "good side down" for a perfectly clean face edge.



Tru-Grip straight edge with width adjustment and clamp.

4.2 ADHESIVES

Use super glue or Gorilla Glue for damage repair and display fabrication. Super glue is fast and high strength. It quickly repairs trade show exhibit and freight damage.

5. MAINTENANCE AND REPAIR

5.1 SCRATCHES

Scratches can be refinished. Stains can be removed. Vandalism can be wiped away. Acetone can refinish, repair and clean storeWALL. It acts as a mild solvent to fill in or remove surface blemishes. Wet a paper towel and wipe down the area for repair. StoreWALL will retain the matte finish.



Scratches cleaned and removed

Scratches and stains

- First, test your technique on a scrap piece of storeWALL or a panel back.
- Acetone is flammable and an industrial chemical. Review the Material Safety Data Sheet (MSDS) before use.
- Acetone can be found in small quantities at drug stores (finger nail polish remover). Larger containers are available at paint stores.

5.2 SURFACE REFINISHING

StoreWALL finish can be refreshed with buffing pads. We have good results with Scotch-Brite pads.

5.3 CLEANING

Use consumer available cleaners with storeWALL. Most industrial cleaners can be used with storeWALL (test scrap or a panel back). Disinfectants and bleaches can be used.

5.4 DAMAGE AND BREAKAGE

Fast, permanent repairs can be made with superglue. Apply glue sparingly and hold parts together to set.

- Thin viscosity superglue is the fastest setting.

5.5 DENTS

A heat gun (or hair dryer) can be used to expand or "pop out" dents.

- Use moderate temperatures. Test your technique on scrap or a panel back.



Break repaired and as strong as the original

6. CONCRETE & BLOCK INSTALLATION

1. Furring Strips

Fasten 1" x 3" furring strips to concrete. Panel installation is the same as wood studs.

Furring strips are wood strips. The 1" (actual thickness 3/4") is sufficient to hold the screw and panel securely. To fasten the furring strips use concrete screws (Tapcon or concrete screws). For added strength use screws and construction adhesive. Furring strips with 16" on-center spacing is suggested.

Panel edges can be finished with our trim pieces or left exposed.

TIP: For a great looking design make storeWALL appear to float on the wall. Furring strips should not be visible at the top, bottom or sides. If the side furring strips can be seen paint the edge with flat black. This is quickly done with an aerosol can of spray paint.

2. Direct to Concrete

Panels can be screwed directly to block or concrete with concrete screws.

Position the storeWALL panel. Drive a pilot hole with a hammer drill using a 1/8" carbide tip bit. Fasten panel to wall with the concrete screw that is designed for concrete installation. For additional fastening strength also use urethane adhesive.

Concrete screws should have a minimum 1" grip in the concrete.

3. Fasten InstallStrips to Concrete

InstallStrips can be fastened to concrete block for the ultimate 'no visible fastener' installation.

Fasten InstallStrips with Tapcon or concrete screws to concrete. Remember that InstallStrips installation requires extremely accurate positioning to maintain strength.

GENERAL TIPS

TIP: When using Tapcon screws drill a 1/8" pilot hole before drilling with the Tapcon carbide tip bit. Using the smaller bit for a pilot hole will help keep the Tapcon hole from wandering and give you more accuracy.

TIP: Concrete block surfaces are not precisely true. The template can slip and result in an incorrect InstallStrip position.

TIP: When drilling in concrete always use a hammer drill. The hammer drill will result in a more accurate hole position and be vastly faster than a conventional drill.



2 x 4 furring strips fastened to concrete block with concrete screws.

7. Screws



Wood and metal studs

Sizes: 1-5/8", 2-1/4"

Features:

- Sharp point drives easily.
- Bugle head drives flush with no counter sink.
- Phillips drive is less visible than square drive.

Available in all storeWALL panel colors.
Rust resistant zinc plate.

The #6 screw is designed for wood studs and metal studs from 20 to 25 gauge. Pre-drilling is not required.

TIP: Wood studs in old construction can be exceptionally hard. Pre-drilling the screw hole can avoid screw breakage.

TIP: You can paint your own favorite fastener. See Installation Tips - Painting screws.

Quantity To Use

Estimate 80 screws per carton of 8 foot storeWALL, or, 2 screws per square foot of installation. This quantity assumes you are driving screws in every other slot with studs 16" on center.

8. BOX EXTENDER

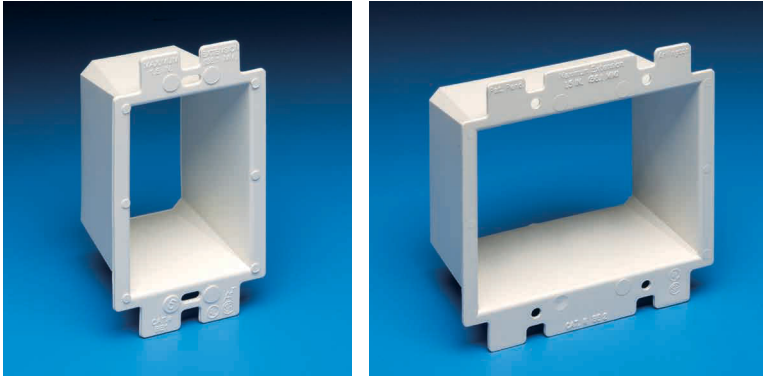

Problem – Electrical box is set back from storeWALL surface.

Solution – Box extender.

A box extender allows you to bring the electrical device to the new wall surface and reinstall the cover plate.

This extender works in handy boxes, 4" square electrical boxes and with plaster rings for single switches or receptacles.

Functions with all standard devices, switches and GFCIs.

Adjusts up to a 1-1/2" box extension.

For multiple gang boxes: trim off sidewall for each extender where the sidewall would join wiring devices.

Non-conductive material for safer installation.

Use 6-32 machine screws.

Screws are not included with box extenders.



Electrical box is behind the new finished wall surface.

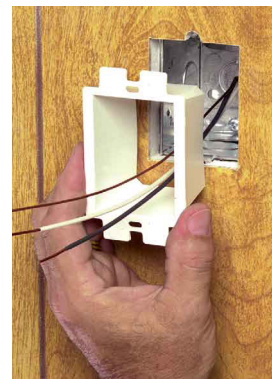

Pass wires through the box extender and attach to receptacle.



(Option) Turn receptacle on side with wires attached and pass through box extender.

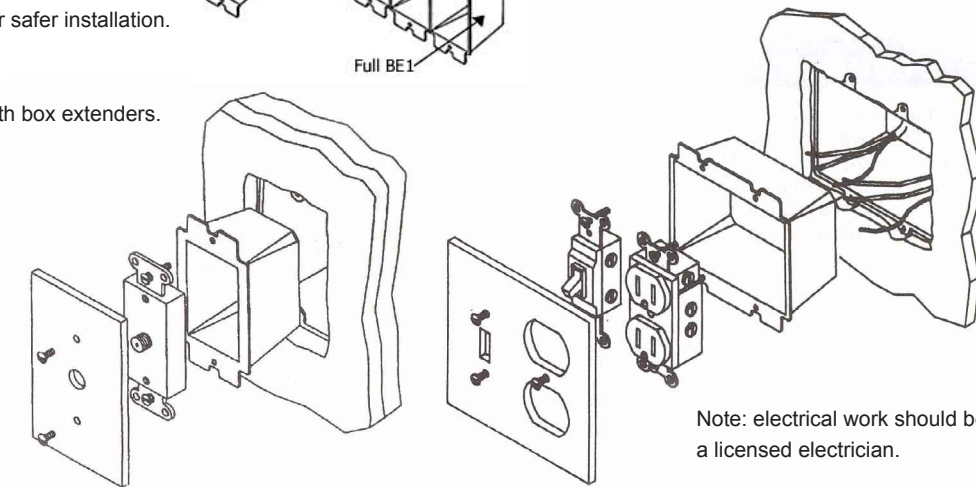
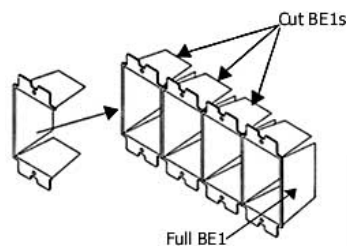

Note: electrical work should be performed by a licensed electrician.

9. BASEBOARD



A garage floor will pitch down from the back to the door. The pitch allows water to run from the garage. The problem is - how to install a base board quickly with a full wall installation.

Install a 6" (or higher) commercial rubber or vinyl base. Use a table saw and cut away the base slot of storeWALL Heavy Duty panel. Install from the garage entrance with the storeWALL bottom at the top of the base. As you install panels to the back of the garage the panel will overlap more of the base.

If the wall is hosed down for cleaning the water drains properly. Just as important the installation looks great!

TIP: The wall panel allows for up to 2 inches of pitch with no additional baseboard trimming.

TIP: Avoid a 4" base. The taller base keeps the wall farther from the floor and the installation will look more professional.

10. SHELF OPTIONS

10.1 5" Shelf

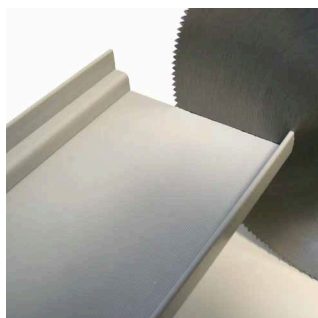

Long or short

The 5 inch shelf is available in ready to use lengths.

Cut with conventional saw blades.



Unique 5" shelf applications

When drilled the shelf provides storage and organization for hard to solve problems. It is an excellent solution for:

- Gadgets
- Specialty tools
- Machined parts
- Collections



Ideal for collection displays.



Perfect tool organization in the shop.



With optional Endcaps the shelf becomes a tray to keep things from falling on the floor.

Endcaps come in pairs and are 'handed' (one pair = 1 right and 1 left).

TIP:
Endcaps add 1/4" to shelf width.

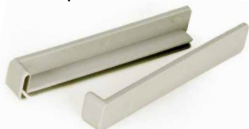

Dremel tool bits conveniently at hand.



Drill with conventional twist drill, spade bit or hole saw.

10.2 10" Shelf & Bracket



One Bracket Packet (with 2 StopSlip Pads and 2 Pine Tree fasteners) is shipped with each shelf bracket. Additional packets can be ordered.

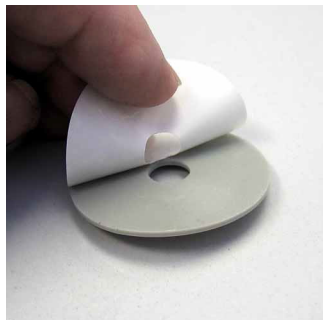

Normal Installation StopSlip™ pads

StopSlip™ pads are anti-skid. Your shelf stays firmly in place and can be repositioned at any time.

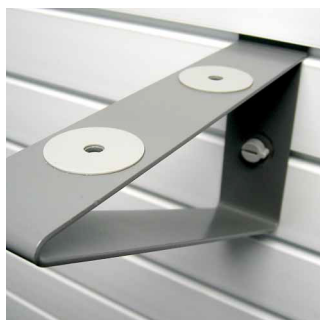

StopSlip™ installation

- 1 The StopSlip pad is peel and stick.
- 2 Apply adhesive side of StopSlip disk to bracket.
- 3 Place shelf on brackets.

PERMANENT Installation Pine Tree fastener

Use the Pine Tree fastener when the shelf is to remain permanently in place

- 1 Place brackets in storeWALL.
- 2 Place shelf on brackets.
- 3 Mark bracket hole positions on underside of shelf.
- 4 Remove shelf and drill 1/4" hole at the marked positions.
- 5 Replace shelf on brackets and align shelf and bracket holes.
- 6 Insert Pine Tree fastener through the underside of bracket into underside of shelf.

